

# SHARP

Be Original.

## MX-B455W MX-B355W

Digital Multifunction System



Much More Than Meets the Eye

simply better **business**



Less bulk, less lag, less hassle —



Simply Better **Experience**

Compact, streamlined, and packed with document functionality, this MFD fits seamlessly into any business setting.



# for Simply Better **Business**



## **Process**

With features normally found on advanced A3 machines, this MFD puts the power of productivity at your fingertips.



## **Admin**

Setting up a secure environment is easy with this MFD, which runs on the same system used by Sharp's A3 machines.

# COPY/PRINT

## Super-Efficient Output and Short Warm-Up Time

The MX-B455W/B355W delivers a fast output of 45/35 ppm\*. The first copy comes out in just 3.7/5.3 seconds, saving you valuable time when performing multiple short-run jobs. The MFD's warm-up time of 20 seconds\*<sup>2</sup> brings added efficiency and reduces overall energy consumption.

\*1: A4, short-edge feeding

\*2: When starting the MFD via the power button. 30 sec. when starting via the main power switch.

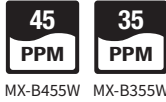

## Space-Efficient Inner Finisher

With the help of this finisher option, the MX-B455W/B355W can handle document sorting and stapling jobs with ease.



## Office Direct Printing

Print common Microsoft® Office files without using a PC. With an MX-B455W/B355W, you can print a Word, Excel®, or PowerPoint® file directly from a mobile device, cloud service, USB drive, or file server.

Note: The actual printout may look different from what is displayed on the computer screen. This function is enabled via DirectOffice™ technology.



## Print Release

The Print Release function lets you send documents to the main MFD, which acts as a server and stores them for printing out from any other compatible MFD on the network. This function comes in handy when the main MFD is in use or under maintenance, letting you finish your job with minimal waiting.

Note: Contact a Sharp customer representative for details on the recommended maximum number of connectable MFDs.

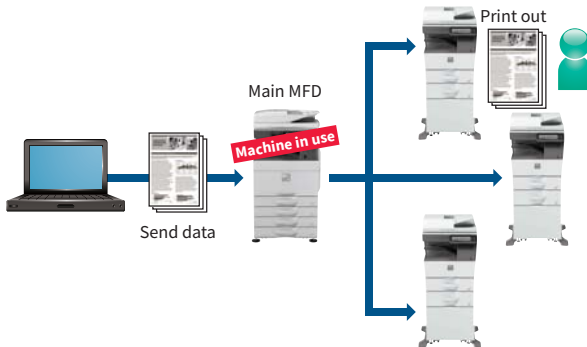

## Printer Driver with Easy Setup

The printer driver setup window features a simple design that includes larger buttons and drop-down menus, making it easier than ever to use printer functions.



## Large Paper Capacity

The MX-B455W/B355W comes standard with a 500-sheet tray and 50-sheet multi bypass tray. An optional 600-sheet paper feed unit is available for a total paper capacity of 2,350 sheets.



## Accommodates Various Paper Sizes

The main unit paper tray and multi bypass tray accommodate a wide variety of paper sizes, including A6. The optional paper feed unit and multi bypass tray handle legal size paper and paper up to 220 g/m<sup>2</sup> thick.

## Copying Originals with Highlighted Lines

Highlighter markings, such as lines, check marks, and circles on a document are usually hard to reproduce. But with these MFDs, they turn out clearly visible in copies.



## PCL 6 and True Adobe® PostScript® 3™

For enhanced font compatibility and improved graphics handling, the MX-B455W/B355W supports both PCL 6 and Adobe PostScript 3.

# SCAN

## Multiple Scan Destinations

Scanned documents can be distributed in a number of ways. A standard-equipped compact PDF function ensures that PDF files are sent and received smoothly. When you're scanning large-volume documents, the MFD saves the data on its hard disk and generates a URL for accessing and downloading that data. You can then e-mail recipients this URL, thereby reducing the load on the mail server.

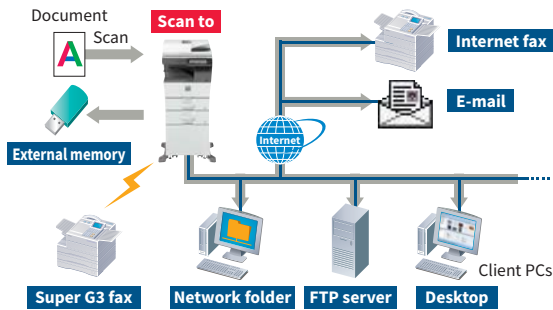

## Convert Documents via OCR

OCR capability on the MX-B455W/B355W lets you convert a scanned document into a searchable PDF file or into an editable Office Open XML (docx, xlsx, pptx) file. This means you can do speedy text searches and easily copy and paste text data into other applications.

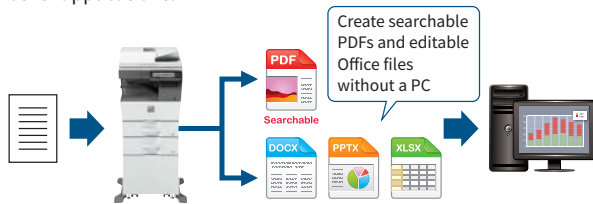

## Business Card Management

Creating and managing a database of business cards is easy with the MX-B455W/B355W. The MFD features a dedicated feeder for scanning batches of up to 25 business cards. It reads contact details on each card via OCR\* and then exports those details to a third-party contact management system of your choice.



\* Scans one side only, even when using document feeder

## Card Shot (Multi) Function

Scan up to four ID or credit cards at once, turn them over, and scan the reverse sides. For each card, a separate file is created that includes the front and reverse sides.

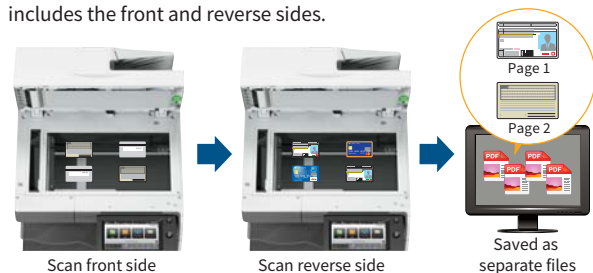

## Quick Scanning

On the MX-B455W, a 100-sheet DSPF (duplex single pass feeder) scans at 110 opm\*<sup>1</sup> (two-sided) or 70 opm\*<sup>1</sup> (one-sided). On the MX-B355W, a 50-sheet RSPF (reversing single pass feeder) scans at 40 opm\*<sup>1</sup> (one-sided). Both the DSPF and RSPF\*<sup>2</sup> include a business card feeder that feeds in batches of up to 25 cards. Such speedy functionality means that even large jobs can be finished quickly and efficiently.

\*1: Originals per minute; when feeding A4 sheets  
\*2: RSPF scans only one side of business cards

## Multicrop Function

The Multicrop function automatically creates separate files for multiple different-sized documents—such as receipts and bills—that are scanned simultaneously.

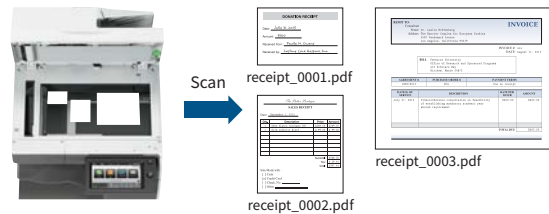

## Image Crop Function

This function lets you scan multiple photos all at once and save each one as a separate file. It can also crop photos on documents such as magazine pages and save them as individual files.

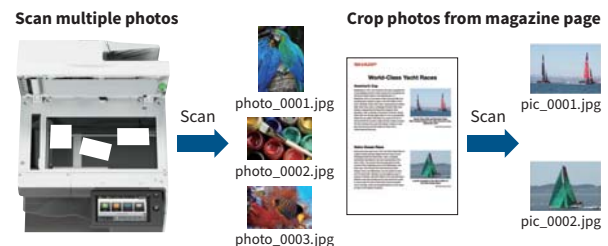

## Easy, High-Quality Scanning

Through an advanced three-step process, **Auto Colour Mode** provides fully automated scanning in both colour and B/W—with a simple press of the Start button. Here's how it works: **Auto Colour Selection** automatically determines whether a page is colour or B/W. **Auto Original Type Selection** then analyses page contents to distinguish between different components (such as photos and text) and selects the appropriate mode. Finally, **Background Suppression** automatically removes unnecessary background colour.

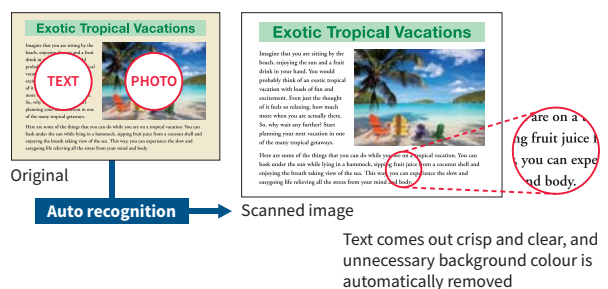

# SHARING

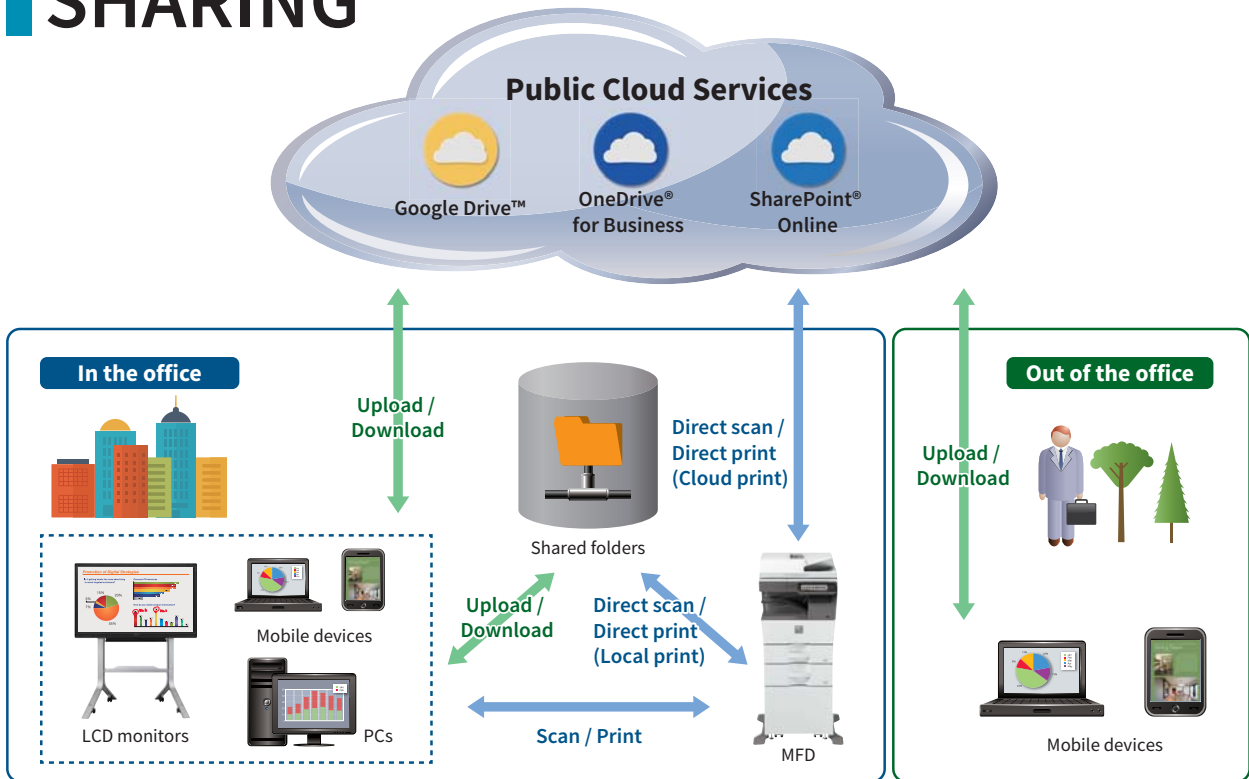

## Link to Cloud Services\*

An MX-B455W/B355W doesn't just connect to your local server. It also connects with cloud services directly from the MFD's control panel. You can upload scanned data to Google Drive, OneDrive for Business, or SharePoint Online—or print directly from any of them. Cloud services help to make setting up and managing a server in your company more efficient. Once you log in to the MFD, its single sign-on feature allows you to quickly access multiple software services without having to sign in to each one separately.

\* Contact a Sharp customer representative for details.

## Link with Mail Servers

Scanned data can be conveniently sent via your Gmail™ or Microsoft Exchange/Online account. Scanned data that you send can be stored on the mail server with other sent items.

## Sharp OSA (Open Systems Architecture)

Sharp OSA technology allows you to interact with intra-company systems and network applications right from the LCD control panel, offering a new realm of control and convenience. And since Sharp OSA utilises industry-standard network protocols, the MX-B455W/B355W can easily integrate with third-party document management systems, enterprise resource planning software, workflow applications, and more. The latest version of Sharp OSA can reach beyond the firewall, enabling extensive system construction as well as services delivered over the Internet such as cloud services. In this way, Sharp OSA provides a foundation for cost reductions and information sharing across the entire company organisation—effectively enhancing total business efficiency.

## Two-Way Sharing with Mobile Devices

• **Sharpdesk Mobile** is a mobile print/scan app that connects the MFD to mobile devices. You can easily link your mobile device to the MFD by simply holding it over the MFD's NFC card reader\* or by scanning the MFD's QR Code®.

\* The NFC interface is for Android™ devices. Requires commercially available NFC card reader. Contact a Sharp customer representative for details.

• **Google Cloud Print™, AirPrint, and Sharp Print Service Plugin** are supported.

## Wireless Connections

The MX-B455W/B355W offers ultra-handly wireless access via two easy modes, enabling convenient access to the MFD even from places where it's difficult to connect a LAN cable.

• **Infrastructure mode** wirelessly connects the MFD to a wireless LAN router connected to the intranet.



• **Access Point mode** wirelessly connects a LAN-wired MFD to mobile PCs/devices without going through a wireless LAN router.



Note: External networks cannot be accessed via the MFD. Up to five mobile devices can be wirelessly connected to the MFD at the same time.

# OPERATION

## Easy User Interface

A user-friendly touchscreen interface incorporating an Easy UI mode makes it easy and intuitive to operate the MFD. In this mode, simple icons are displayed on the 7.0-inch colour LCD touchscreen. The Advanced Preview function, meanwhile, lets you check document finishes and page layout in advance, edit pages easily, and preview documents in various modes.

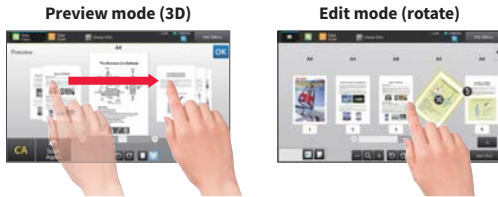

## Device Management

Sharp Remote Device Manager\* (SRDM) gives administrators centralised control of their networked MFDs. This software covers system setup, security settings, troubleshooting, and more.

\* Contact a Sharp customer representative for availability and other details.

## Free-Tilting Control Panel

The control panel can be tilted freely at various angles for easy viewing and easy operation, even from a wheelchair.



## Direct Printing/Scanning with USB Drives

Insert a USB drive into the MFD and a command screen will automatically pop up on the LCD. Right away you can print files from the USB drive or scan documents directly to the USB drive.



## LED Status Lamps

Next to the control panel are two LED lamps: one red, one green. These light up to notify you—even from a distance—of the status of the machine.



# SECURITY

## Network Security and Access Control

- **S/MIME** provides secure e-mail communications\*  
\* Only when e-mailing scanned data.
- **SSL** (secure sockets layer) and IPsec data encryption technologies ensure secure network communications
- **User authentication** prevents unauthorised MFD use by requiring passwords
- **Active Directory**® enables integrated management of user credentials, thereby providing a highly secure and efficient environment for system administrators

## Document and Data Protection

- **Document Control**\* prevents unauthorised use of confidential documents by embedding copy prevention data in them  
\* Requires optional MX-FR59U. May not work with certain types of paper, documents (such as those with a lot of photos), or MFD settings.
- **Hidden Pattern Copy/Print** embeds a watermark onto a document
- Job data is automatically **encrypted**\* before being saved to the MFD's internal storage  
\* Contact a Sharp customer representative for details on activating this function.
- Retained data can be **initialised** when it's time to replace the MFD, preventing the leakage of confidential information

## SYSTEM CONFIGURATION

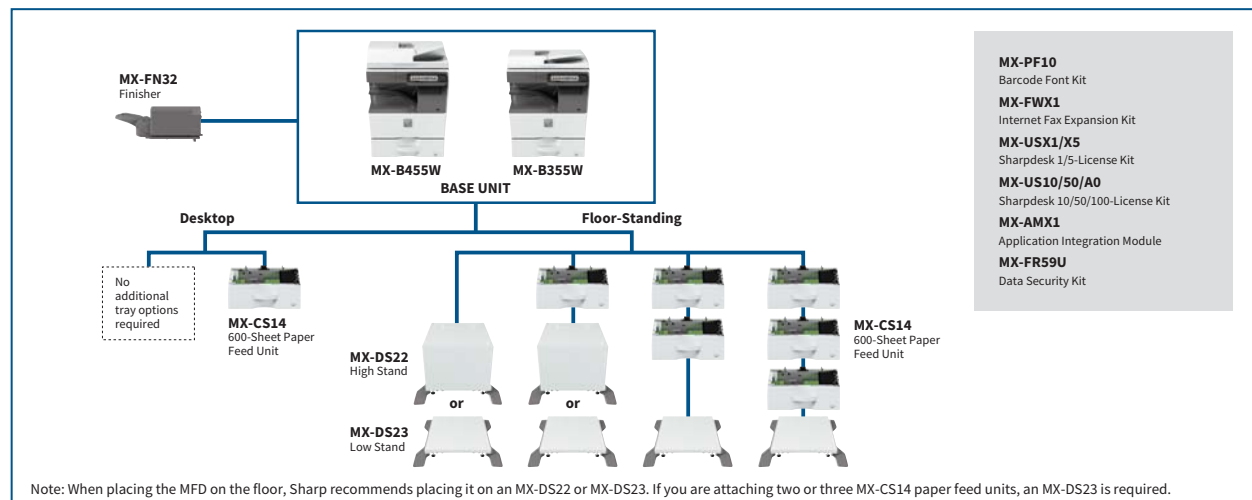

## SPECIFICATIONS

### General

Type	Desktop
Engine speed	A4*1: Max. 45/35 ppm
Control panel display	7-inch colour LCD touchscreen
Paper size	Max. A4, min. A6
Paper capacity (80 g/m <sup>2</sup> )	Standard: 550 sheets (500-sheet tray and 50-sheet multi bypass tray) Maximum: 2,350 sheets (550 sheets & optional 600-sheet tray x 3)
Paper weight	Tray 1: 60 g/m <sup>2</sup> to 105 g/m <sup>2</sup> Trays 2-4 (MX-CS14): 55 g/m <sup>2</sup> to 220 g/m <sup>2</sup> Multi bypass tray: 55 g/m <sup>2</sup> to 220 g/m <sup>2</sup> 20 sec.*3
Warm-up time*2	
Memory	5 GB (copy/print shared) 500 GB HDD*4
Power requirements	Rated local AC voltage ±10%, 50/60 Hz
Power consumption	Max. 1.84 kW (220 V to 240 V)
Dimensions (W x D x H)*5	MX-B455W: 492 x 517*6 x 638 mm MX-B355W: 492 x 517*6 x 588 mm
Weight (approx.)	MX-B455W: 33 kg MX-B355W: 31 kg

### Copier

Original paper size	Max. A4
First copy time*7	MX-B455W: 3.7 sec. MX-B355W: 5.3 sec.
Continuous copy	Max. 9,999 copies
Resolution	Scan: 600 x 600 dpi, 600 x 400 dpi Print: 600 x 600 dpi, 9,600 (equivalent) x 600 dpi (depending on copy mode)
Gradation	Equivalent to 256 levels
Zoom range	25% to 400% (25% to 200% using DSPF/RSPF) in 1% increments
Pre-set copy ratios	Metric: 10 ratios (5R/5E), inch: 7 ratios (4R/3E)

### Network Colour Scanner

Scan method	Push scan (via control panel) Pull scan (TWAIN-compliant application)
Scan speed*8 (colour & B/W)	[MX-B455W] One-sided: Max. 70 originals/min. Two-sided: Max. 110 originals/min. [MX-B355W] One-sided: Max. 40 originals/min.
Resolution	Push scan: 100, 150, 200, 300, 400, 600 dpi Pull scan: 75, 100, 150, 200, 300, 400, 600 dpi 50 dpi to 9,600 dpi via user setting*9
File formats	TIFF, PDF, PDF/A, encrypted PDF, compact PDF*10, JPEG*10, XPS, searchable PDF, OOXML (docx, xlsx, pptx), text (TXT [UTF-8]), rich text (RTF)
Scanner utility	Sharpdesk
Scan destinations	Scan to e-mail/desktop/FTP server/network folder (SMB)/ USB drive/HDD

\*1: Short-edge feeding.

\*2: In a standard measurement environment. May vary depending on operating conditions and environment.

\*3: When starting the MFD via the power button. 30 sec. when starting via the main power switch.

\*4: HDD capacity depends on procurement and sourcing status.

\*5: Including adjusters and protuberances.

\*6: 533 mm when the control panel is tilted at the flattest horizontal angle.

\*7: Short-edge feeding of A4 sheets from 1st paper tray, using document glass, MFD in fully ready condition. May vary depending on operating conditions and environment.

\*8: Scan speed will vary depending on the type of document and the scan settings. MX-B455W: Based on Sharp's A4 standard chart, using document feeder, short-edge feeding, and factory default settings. MX-B355W: Based on Sharp's A4 standard chart, using document feeder, short-edge feeding, one-sided scanning, and factory default settings.

\*9: Resolution will vary depending on the size of the scanned area.

\*10: Colour/greyscale only.

\*11: Storage capacity will vary depending on the type of document and the scan settings.

\*12: Based on Sharp's standard chart with approx. 700 characters (A4 short-edge feeding) at standard resolution in Super G3 mode, 33,600 bps, JBIG compression.

### Document Filing

Document filing capacity*11	Main and custom folders: 20,000 pages or 3,000 files Quick file folder: 10,000 pages or 1,000 files
Stored jobs	Copy, print, scan, fax
Storage folders	Quick file folder, main folder, custom folder (max. 1,000 folders)

### Network Printer

Resolution	600 x 600 dpi, 9,600 (equivalent) x 600 dpi
Interface	USB 2.0 (host, high-speed), 10Base-T/100Base-TX/1000Base-T
Supported OS	Windows Server® 2008, Windows Server® 2008 R2, Windows Server® 2012, Windows Server® 2012 R2, Windows Server® 2016, Windows® 7, Windows® 8.1, Windows® 10, Mac OS 10.6, 10.7, 10.8, 10.9, 10.10, 10.11, 10.12, 10.13
Network protocols	TCP/IP
Printing protocols	LPR, Raw TCP (port 9100), POP3 (e-mail printing), HTTP, FTP for downloading print files, IPP, SMB, WSD
PDL	PCL 6 emulation, Adobe® PostScript® 3™
Available fonts	80 fonts for PCL, 139 fonts for Adobe PostScript 3

### Facsimile

Compression method	MH/MR/MMR/JBIG
Communication protocol	Super G3/G3
Transmission time	Less than 3 seconds*12
Modem speed	33,600 bps to 2,400 bps with automatic fallback
Transmission resolution	From Standard (203.2 x 97.8 dpi) to Ultra Fine (406.4 x 391 dpi)
Recording size	A4 to A5
Memory	1 GB (built-in)
Greyscale levels	Equivalent to 256 levels

• Design and specifications are subject to change without prior notice.  
• Microsoft, Excel, PowerPoint, Active Directory, OneDrive, SharePoint, Windows Server, and Windows are either registered trademarks or trademarks of Microsoft Corporation in the US and/or other countries. PCL is a registered trademark of Hewlett-Packard Company. Adobe and PostScript are either registered trademarks or trademarks of Adobe Systems Incorporated in the US and/or other countries. Google Drive, Gmail, Android, and Google Cloud Print are trademarks of Google LLC. The Google Drive trademark is used with permission from Google LLC. QR Code is a registered trademark of DENSO WAVE INCORPORATED in Japan and other countries. AirPrint and Mac are trademarks of Apple Inc., registered in the US and other countries. DirectOffice is a product of CSR Imaging US, LP. DirectOffice is a trademark of CSR Imaging US, LP, registered in the US and other countries, used with permission. All other brand names and product names may be trademarks or registered trademarks of their respective owners.

**DIRECTOffice**

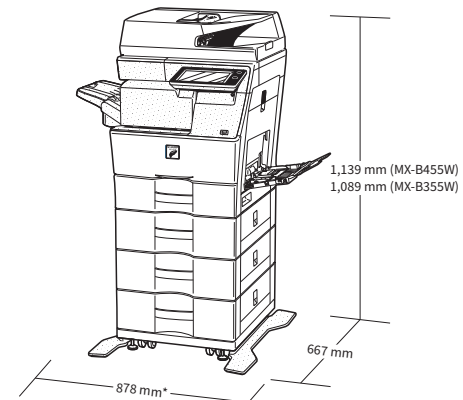

\* When finisher tray and multi bypass tray are extended.

MX-B455W shown with optional equipment.

Distributed by:

# SHARP

**SHARP CORPORATION OF AUSTRALIA PTY LTD**  
 ABN 40 003 039 405  
 P.O. Box 84, Macquarie Park, NSW 2113  
 Tel: (02) 9830 4600  
 www.sharp.net.au